

VELUX CABRIO® roof balcony GDL

VELUX®

Glazing 66SG



Transform your home and feel like being outside by simply opening your VELUX CABRIO® roof balcony. The innovative balcony opens in seconds to give your home more space, daylight and fresh air. Consisting of a top-hung roof window and a bottom section that unfolds into a glazed balcony with elegant balustrades, it's a balcony experience like no other.

- Enjoy extra space by converting your VELUX CABRIO® roof window into a balcony.
- Open the top section of the balcony for fast access to fresh air.
- Elegant side banister railings provide extra safety and a clear view to the outdoors.
- Open the window outwards up to 45° to enjoy a panoramic view and a feeling of space.
- The glazing comes standard with premium features like safety lamination, toughened glass, UV filter, easy to clean, anti-dew and our unique rain noise reduction.
- Comes with a choice of white-painted surface to match most contemporary interiors or clear-lacquered surface for a natural wood atmosphere.
- Reduce your energy bill and increase your indoor comfort with VELUX ThermoTechnology™.



Application guidance

The roof balcony can be installed in roof pitches between 35° and 53° to the horizontal.



The upper section of the balcony is a bottom-operated, top-hung roof window that opens outwards for an unobstructed, panoramic view. When the upper section is opened, the lower section can be pushed outwards to vertical position. As the lower section opens, integrated banister railings are raised on both sides.

To get the full benefit of the balcony, we recommend an installation height that allows for a clear sight line to the outside from both a standing and seated position.

Available sizes and daylight area

	780	942
2520	GDL MK19 (1.28)	GDL PK19 (1.63)

All measurements are in mm. () = Effective daylight area, m²



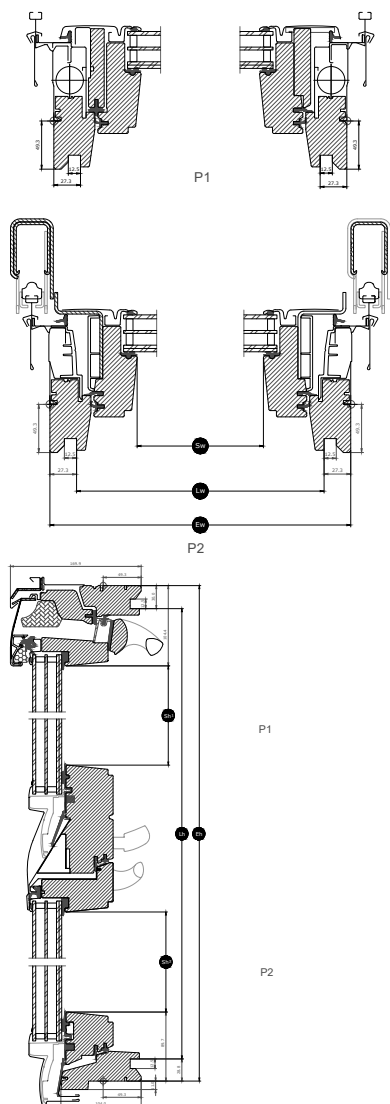





Cross section dimensions

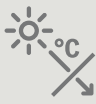

Width		MK--	PK--
Sw	Sash aperture width	601	763
Lw	Distance between lining grooves, width	725	887
Ew	Exterior frame width	780	942

Height		--19
Sh	Sash aperture height	1406 729
Lh	Distance between lining grooves, height	2461
Eh	Exterior frame height	2520

Glazing features

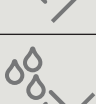
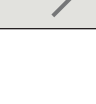
Glazing 66SG		
	Heat insulation The low energy glazing unit reduces heat loss through the window and enhanced indoor comfort.	$U_g = 0.6$
	Solar gain In colder climates and in rooms with large window areas, solar gain provides a better indoor climate during winter periods.	$g = 0.44$
	Solar protection In warm climates and in rooms with large window areas, a sun protective glazing unit provides a better indoor climate during summer periods.	★★★★☆
	Security Thicker laminated inner glass increases resistance to manual attack (burglary).	★★★★☆
	Safety lamination Prevents glass from falling into the room in case of accidental breakage.	✓
	Toughened glass Adds strength to the outer pane to protect from wayward balls and extreme weather such as heavy storms and hail.	✓
	UV filter Protects your interior furnishings from fading due to the sun's harmful UV rays.	✓
	Rain noise reduction Rain noise reduction creates a barrier between the window and the weather outside for undisturbed moments during rainy days – or nights.	✓
	Easy-to-clean Dirt-repellent coating lets you spend less time cleaning and more time enjoying the view.	✓
	Anti-dew The anti-dew coating significantly reduces the days with dew on the outer glass and thus gives you a clear view.	✓

Glazing structure

Glazing unit	Composition (from inside to outside)
Triple-glazed	6.8 mm laminated float glass - 13 mm Argon - 3 mm heat strengthened glass - 13 mm Argon - 4 mm toughened glass

Technical values for the window

Overview of technical values for the product, covering CE marking in accordance with EN 14531 and other EN standards.

Window characteristics	Performance
Thermal transmittance (U-value)	1.2 W/(m ² K)
Light transmittance (τ _v)	0.62
Total solar energy transmittance (g-value)	0.44
Sound insulation	37(-2;-4)
Air permeability	3
External fire performance - British	npd
External fire performance - European	npd
Impact resistance	3
Load-bearing capacity of safety devices	√
Reaction to fire	C-s1,d2
Resistance to snow load	See glazing composition
Resistance to wind load	C3 (>SK08: NPD)
Water tightness	9A

NPD: No Performance Determined

Visible features



Operating handle, roof balcony

The lower section is easily pushed outwards to vertical position by using the two handles.



Lifting device, top-hung

The lifting device facilitates the opening of the top-hung sash, once engaged with the spring rods.

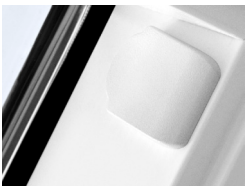

Blind bracket, manual

Easily install blinds on the window without the need for extra tools. Simply click on the blind in the pre-fitted brackets.



Frame hinge, centre-pivot, side

Durable hinge design allows for reliable operation and enables the sash to be rotated for easy cleaning of the outer pane.

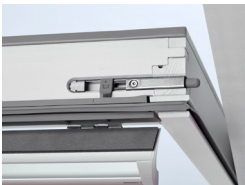

Barrel bolt

The barrel bolt can be placed into the integrated barrel bolt bushing to secure the window for cleaning of outer glass surface or for safe ventilation.



Ventilation flap, pine wood

The full-width ventilation flap can be used for ventilation even with a closed window. The ventilation flap is connected to the top sash with the lock casing.



Interior insulation, frame top sides

Innovative ThermoTechnology™ insulation is integrated into the top frame sides of the window to increase energy-efficiency.

Interior finish

Material Description	Clear lacquer Finished with triple coat, clear lacquered.	White-painted Finished with triple coat, white painted.
Colour code NCS, inner surface	-	S 0500-N
Colour code nearest RAL, inner surface	-	9003

Exterior covers

Material Description	Aluminium, dark grey Dark grey	Titanium zinc	Untreated copper
Colour code NCS, outer surface	S 7500-N	No colour code	No colour code
Colour code nearest RAL, outer surface	7043	No colour code	No colour code

Cleaning and maintenance

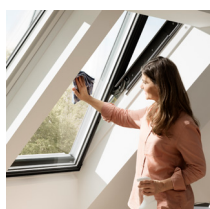

Upper section:
To clean the outer glass from the inside, open the window and rotate fully. Secure the sash in this position by sliding the barrel bolt on the right side of the top sash into the bushing at the bottom of the side frame.

Lower section:
To clean the outer glass from the inside, open the upper section fully to reach the lower section.



VELUX repair and maintenance kits are available.

Guarantee period

Flashings and installation products



Flashings

Install the VELUX roof window in virtually any roofing material by using genuine VELUX flashing solutions. Our flashings are designed specifically for the exact size and shape of the roof windows to create perfect, watertight fit. Flashings can also be used to combine multiple roof windows.

Installation products

Ensure a proper installation and an air- and watertight connection between the window and roof with VELUX installation products. All installation products are designed to perfectly fit the roof window for a reliable and durable result.

Blinds, awnings and shutters

Complete the VELUX roof window installation with roller shutters and awning blinds for heat protection and interior blinds for light dimming, blackout and insect protection. Choose from a wide range of manually operated or remote-controlled products that are made to fit the particular window type and size. Please contact your local VELUX sales company for more details about compatibility.

Further information

We reserve the right to make technical changes.

For more information on our products, please visit <https://velux.com>.